

OKOndt GROUP

FAMILY OF TOFT PRODUCTS



**CEN/TS 14751:2004
Compliant**
**EN 5836:2000
Compliant**

OKOndt GROUP



PURPOSE

TOFD Systems are intended for mechanized ultrasonic testing of welded joints using Time of Flight Diffraction (TOFD) technique. The System is used for the butt welded joints UT at:

- flat objects;
- tubes of medium and large diameters – OD not less than 12 in (300 mm) – depends on the scanner type;
- spherical and cylindrical oil and gas tanks – OD not less than 33 ft (10 m).

CONFIGURATIONS OF TESTED WELDED JOINTS:

- profile types: CRC-Evans, single J groove weld, single V groove weld, double V groove weld, x-welds, etc.;
- wall thickness: .25 in (6 mm) to 12 in (300 mm);
- tube and plate material: standard carbon steels and some others.

PRODUCTS FAMILY OVERVIEW

OKO Association presents several products which can be used according to the testing object and conditions specifics:

- **TOFD MAN™** is our latest solution for easy testing of both medium-diameter pipelines and large objects, primarily those that require the use of climbing equipment during the scanning process. All equipment of **TOFD MAN™** is put in a specially designed load-release jacket, thanks to which the weight of the equipment is practically not felt. TOFD 2.2 Lite scanner that is included into the standard-type system can be also attached to the jacket belt when testing is not being per-

formed. All data are transferred to a remote laptop or tablet via wireless Wi-Fi interface.

To solve various NDT tasks, **TOFD MAN™** can be provided with one of our scanners: TOFD 2.11 PRO or TOFD 2.1 Dragonfly.

- TOFD 2.2 PRO System is based on a manual scanner TOFD 2.2 PRO that incorporates not only encoder and probes, but also electronics and battery. This scanner is ideal for testing large pipelines or other similar objects. Here, all data are transferred to a remote laptop or tablet via wireless Wi-Fi interface, too.

TOFD TECHNIQUE DESCRIPTION, FEATURES AND COMPLIANCE WITH STANDARDS

Time of Flight Diffraction (TOFD) technique is based on diffraction of ultrasonic waves from the tips of discontinuities.

This method is even more reliable than traditional radiographic, pulse echo manual

UT and automated UT weld testing methods. TOFD offers great accuracy for measuring the critical through-wall size of crack-like-defects. The accuracy of better than $\pm 1\text{mm}$ can be obtained in a wide range of material thickness.

Main advantages of TOFD are:

- Detects defects regardless their orientation, in contrast to the pulse echo technique.
- In contrast to the radiography method, planar defects and cracks, which are not perpendicular to the measured surface can be detected.
- High degree of repeatability.
- Precise defect sizing capability.
- Fast scanning only along the weld. Full volume inspection in a single run.
- Immediate results and permanent digital records with graphic images.
- Amplitude insensitive – acoustical coupling less critical.
- Setup independent of weld configuration.

The TOFD PRO systems comply with: CEN/TS 14751:2004; ENV 583-6:2000; AMSE Section V, Art. 4, Mand. App. III and similar codes.

Testing scheme by TOFD technique

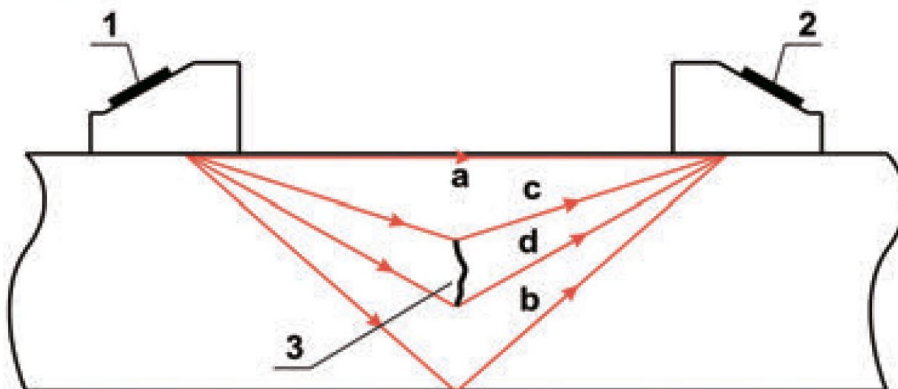

Displaying the signals on A-scan

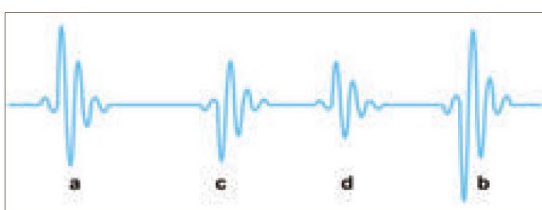

- 1 - transmitter;
- 2 - receiver;
- 3 - internal crack;
- a- lateral wave;
- b- back wall echo;
- c- diffracted signal from the top tip;
- d- diffracted signal from the bottom tip.

TOFD Systems software consists of the queue of tabs guiding the inspector through step-by-step setup procedure, data acquisition and analysis. Software is both mouse and finger friendly so can be used on various types of computers – tablets, laptops, desktops, etc. Setup process is greatly facilitated due to wide usage of setup elements libraries – Geometry library, Materials library, Scanners library, Probes library, etc. So the major portion of the setup procedure shrinks to choosing of proper elements from those libraries. Complete setup packs suitable for particular testing tasks can be saved and then loaded at any time.

SOFTWARE

THE SYSTEM SOFTWARE INCLUDES THE FOLLOWING PAGES (MODULES):

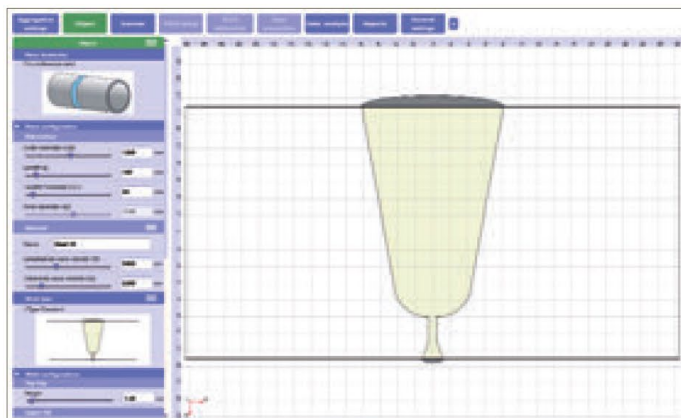

- The “**Object**” page ensures:
- selecting the test object geometry and setting up its geometrical dimensions;
 - selecting the type of test object material;
 - selecting the type of a weld bevel and setting up all geometrical dimensions.

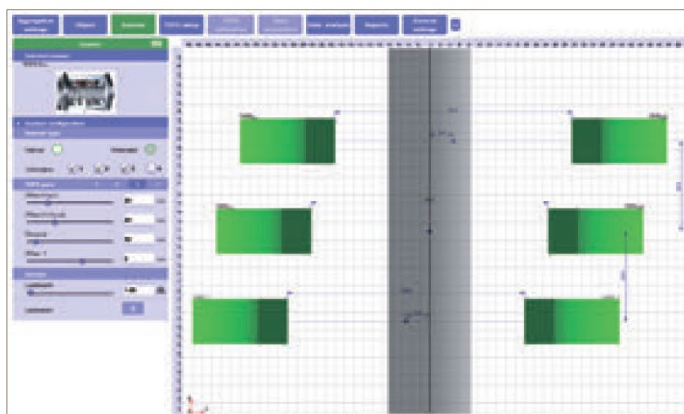

- The “**Scanner**” page ensures:
- selecting the scanner;
 - setting up the scanner type: manual, motor-operated;
 - setting up the spatial position of TOFD-transducers pair relative to the origin of the coordinate system;
 - using of up to 4 TOFD transducer pairs;
 - carrying out the encoder calibration.

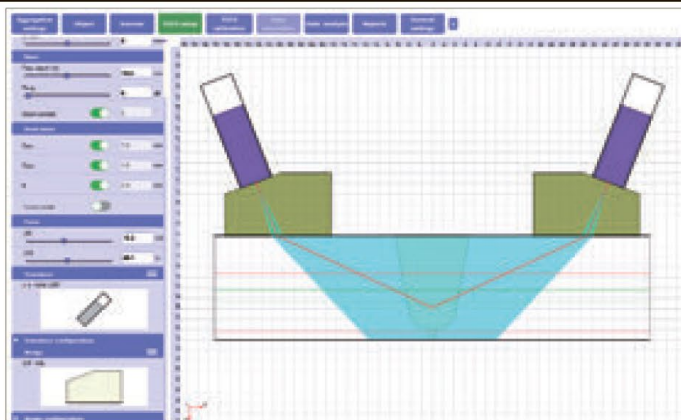

- The “**TOFD setup**” page ensures:
- selecting the type of TOFD probes, TOFD wedges, operating set up of their parameters;
 - setting up the PCS - the distance between the index points of TOFD transducers and their shift relative to the welded joint axis;
 - calculation and graphic plotting of the following parameters when using the TOFD Calculator:
 - Spatial resolution (R);
 - Scanning-surface dead zone (D_{ds});
 - Backwall dead zone (D_{dw});
 - Locus curve;
 - Beam Spread.

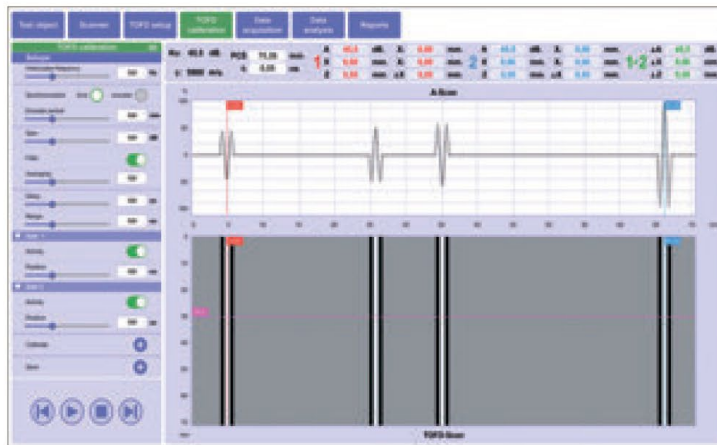

TOFD calibration

Fast and intuitive calibration procedure can be done directly at the testing object or in lab.

The “TOFD calibration” page ensures:

- setting up the testing parameters for TOFD;
- carrying out the real-time TOFD calibration by saved data;
- real-time check up of reflectors detection in calibration block;
- generating the parameters matrix of calibration block reflectors;
- saving the calibration results.

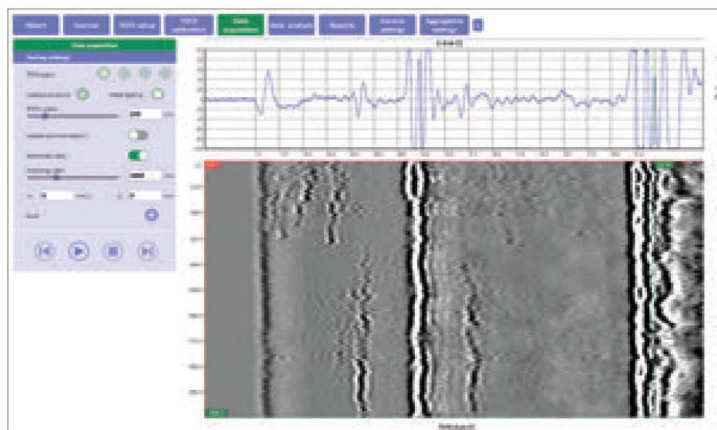

Data acquisition

The “Data acquisition” page ensures:

- data display in a form of A-Scan together with TOFD-Scan during the testing process;
- carrying out the testing and data acquisition with an auto stop of a testing mode
- displaying the current scanner position (the coordinate along the scanning path) and the scanning speed;
- data synchronization during the testing process by lateral wave;
- considering the scanning direction and capability to perform the confirming testing of regions with the loss of acoustic coupling;
- saving the testing results.

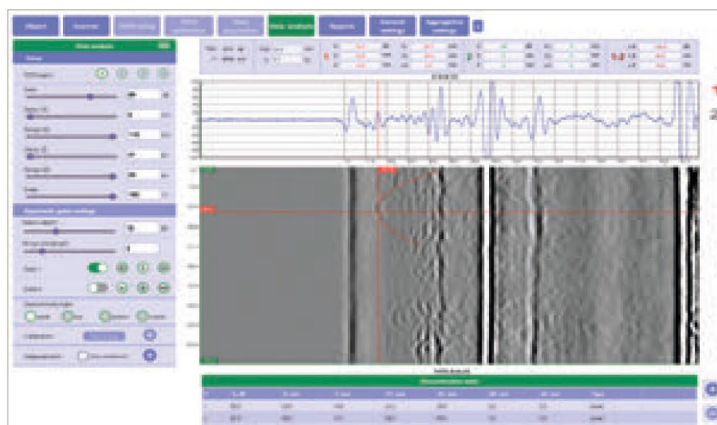

Data analysis

The “Data analysis” page ensures:

- review and analysis of saved data in a form of A-Scans and TOFD-Scans;
- quick and detailed analysis of testing results while using two measuring gates (type: simple, hyperbolic, hyperbolic manual);
- discontinuities detected by TOFD shall be characterized by at least:
 - their position in the object (X and Y coordinates);
 - their length (ΔX);
 - their depth and height (Z , ΔZ);
 - their type, limited to: “top-surface breaking”, “bottom-surface breaking” or “inner”.
- generating the defects table and its saving.

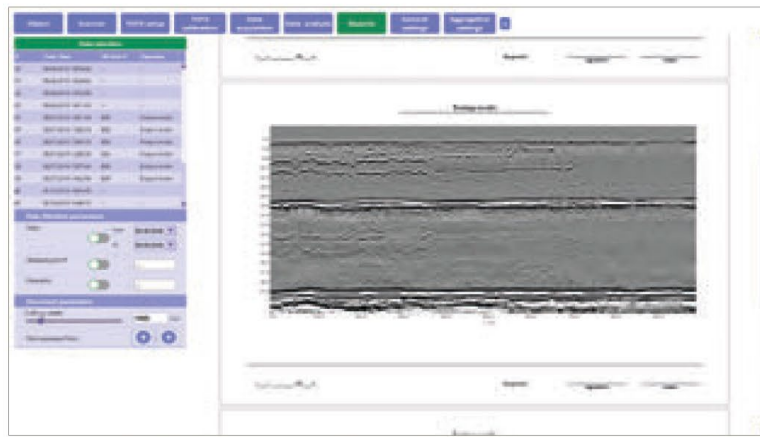

The "Reports" page ensures:

- generating the reports according to the requirements of Regulatory Documentation CEN/TS 14751:2004, ENV 583-6:2000;
- approval of report forms with the customer when necessary.

The software is designed for ease of use, flexibility and scalability, and is oriented for a touchscreen operation.

The user interface is optimized for the accelerated learning process and improving the efficiency of use.

TOFD PRO SYSTEM COMPOSITION

INDUSTRIAL LAPTOP OR TABLET WITH SOFTWARE



Shockproof industrial laptop/tablet with installed Microsoft Windows and special software for TOFD setup, data acquisition, analysis and reporting.

DATA ACQUISITION TOFD UNIT

The System may contain of up to 4 data acquisition TOFD units.

TOFD unit ensures data acquisition and transmission in real-time mode via Ethernet-interface to industrial notebook or tablet.

Unit case is made of shock-proof material.

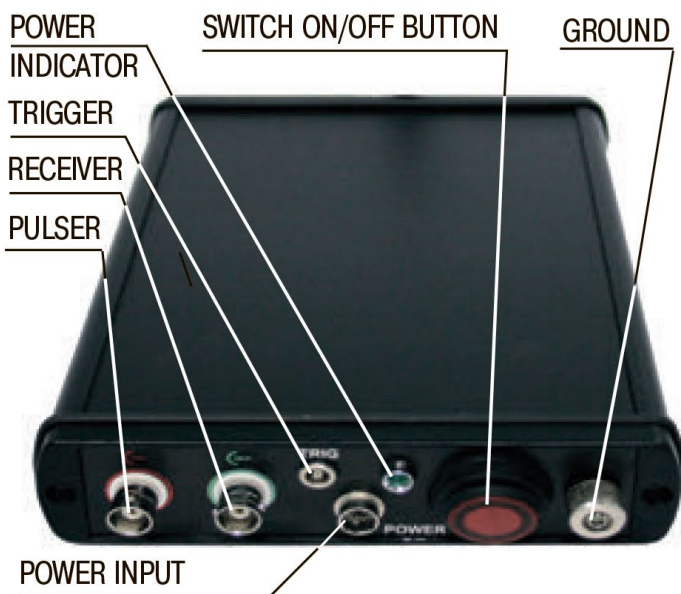

SCANNER

The System is completed with one scanner. For information on possible scanners available below in the section "Scanners"

COUPLANT-FEED UNIT

Couplant is supplied to the scanner with motorized pump.

Couplant feed control is carried out with regulating valve set on the scanner.

TOFD MAN™ System

The system is designed for testing long welded joints of pipes, tanks, vessels, cisterns, ship hulls, bridges, etc. using TOFD technique. Circumferential welds with a diameter from 12 in (300 mm) can be inspected on cylindrical objects. On cylindrical, spherical, as well as complex-shaped objects with a radius of surface curvature from 16 ft (5 m) to flatness, the system is capable of testing long welds in any direction. Objects with wall thickness from .25 to 12 in (from 6 to 300 mm) can

be examined with the help of appropriate probes. Depending on the inspection task, TOFD MAN™ system can be complete with another scanner (see “Scanners”). The amount of probe pairs can vary from 1 to 4. For good coupling, it is advised to use an external coupling liquid supply system. In this case, a water hose will come to the scanner. But if absolute mobility is needed, coupling media can be applied to the object before testing, or a test object can be continuously showered with water.

Configuration of the system is maximally optimized for placement on the operator's jacket, which does not impede the move-

ment, also when performing an inspection at height (climbing, rope access). Standard delivery set of the system features an 8-hour battery to be put in the jacket. The scanner is light-weighted and easy to guide. It ensures handy probes setup.

In the course of and testing, all setup data are transferred to a remote PC (laptop or tablet) via Wi-Fi. A system for protecting the integrity of test data is provided, while they are fully stored inside the TOFD module and transferred to PC at the end of testing. If required, it is possible to use a wire connection to transmit data to PC.



TOFD 2.2 PRO System

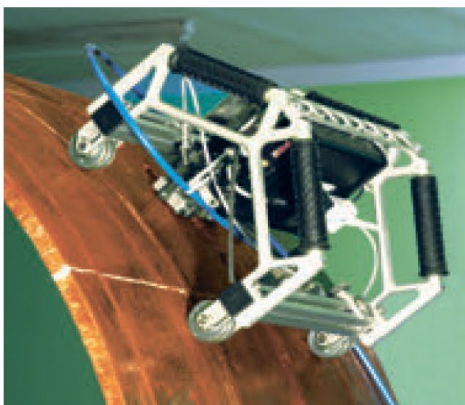

The system is primarily intended for testing circumferential welds of large pipelines and other cylindrical objects with a diameter from 24 in (600 mm), as well as spherical objects with a diameter from 33 ft (10 m), wall thickness from .25 to 12 in (from 6 to 300 mm) inspected provided that the probes being changed.

'All-On-Board' philosophy of the system means that the scanner accommodates all electronics, including an 8-hour battery. The scanner is rigid, easy-to-guide and wireless due to the fact that TOFD module, power unit and Wi-Fi module are placed onboard. For good coupling, it is advised to use an external coupling liquid supply system. In

this case, a water hose will come to the scanner. But if absolute mobility is needed, coupling media can be applied to the object before testing, or a test object can be continuously showered with water. If required by the customer, it is possible to supply a modified standard-type scanner that would include not one but two pairs of probes.

A system for protecting the integrity of test data is provided, while they are fully stored inside the TOFD module and transferred to PC at the end of testing. If required, it is possible to use a wire connection to transmit data to PC.

**WIRELESS TECHNOLOGY
OF TOFD DATA TRANSFER**



TOFD SCANNERS

To meet requirements of a variety of testing tasks solved with TOFD technique, OKO Association has developed and continue developing a product line of TOFD scanners presented below.

TOFD 2.2 Lite scanner

TOFD 2.2 Lite scanner is a great solution for testing of both butt welds at large objects (like oil and gas storages, ship hulls, etc) and circular butt welds on medium and large diameter pipelines – starting from dia 12 in (300 mm).

Scanner can carry one pair of probes and can be modified to carry 2 pairs of probes on request.

Scanner is light weighted and easy to guide. It ensures coupling liquid supply to the working surfaces of each probe individually for good coupling.

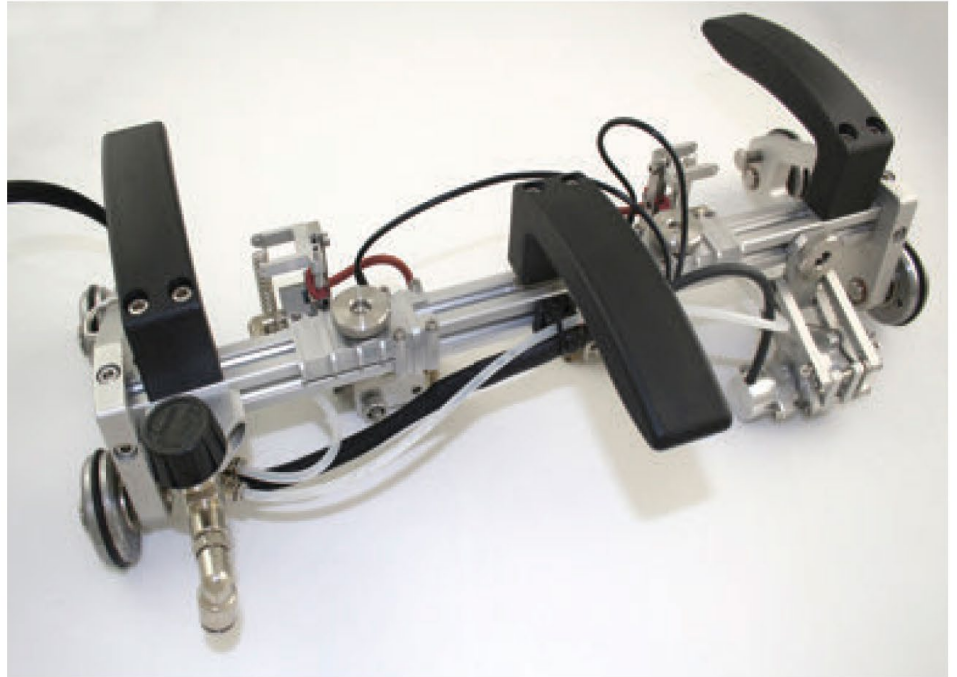



TOFD 2.11 PRO

TOFD 2.11 PRO scanner is intended for testing of the ring welded joints of pipes and boilers with the diameter above 24 in (600 mm) and wall thickness from .25 to 12 in (from 6 to 300 mm) and also flat and large diameter objects such as ships hulls, oil and gas storage tanks, etc.

This scanner can carry up to 2 pairs of probes and can be modified to carry up to 4 pairs of probes on request.

Scanner is rigid and comfortable to guide. It ensures coupling liquid supply to the working surfaces of each probe individually for good coupling.

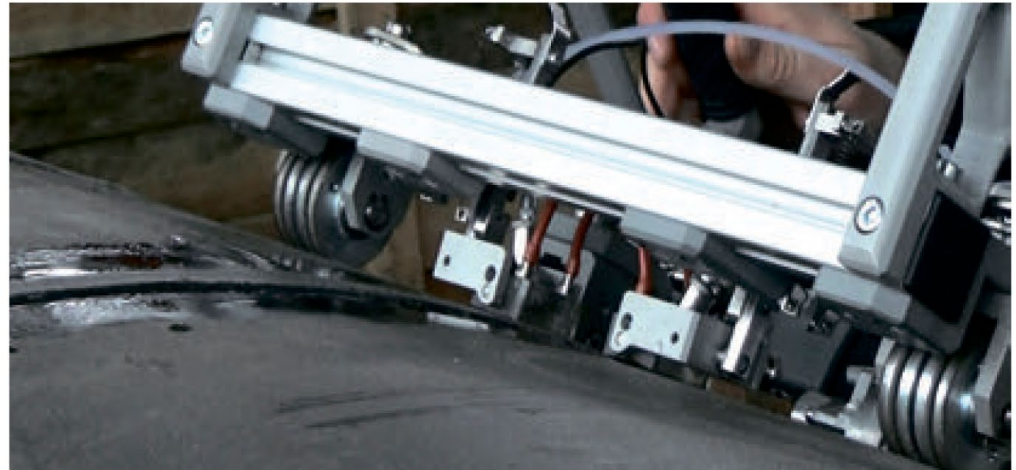

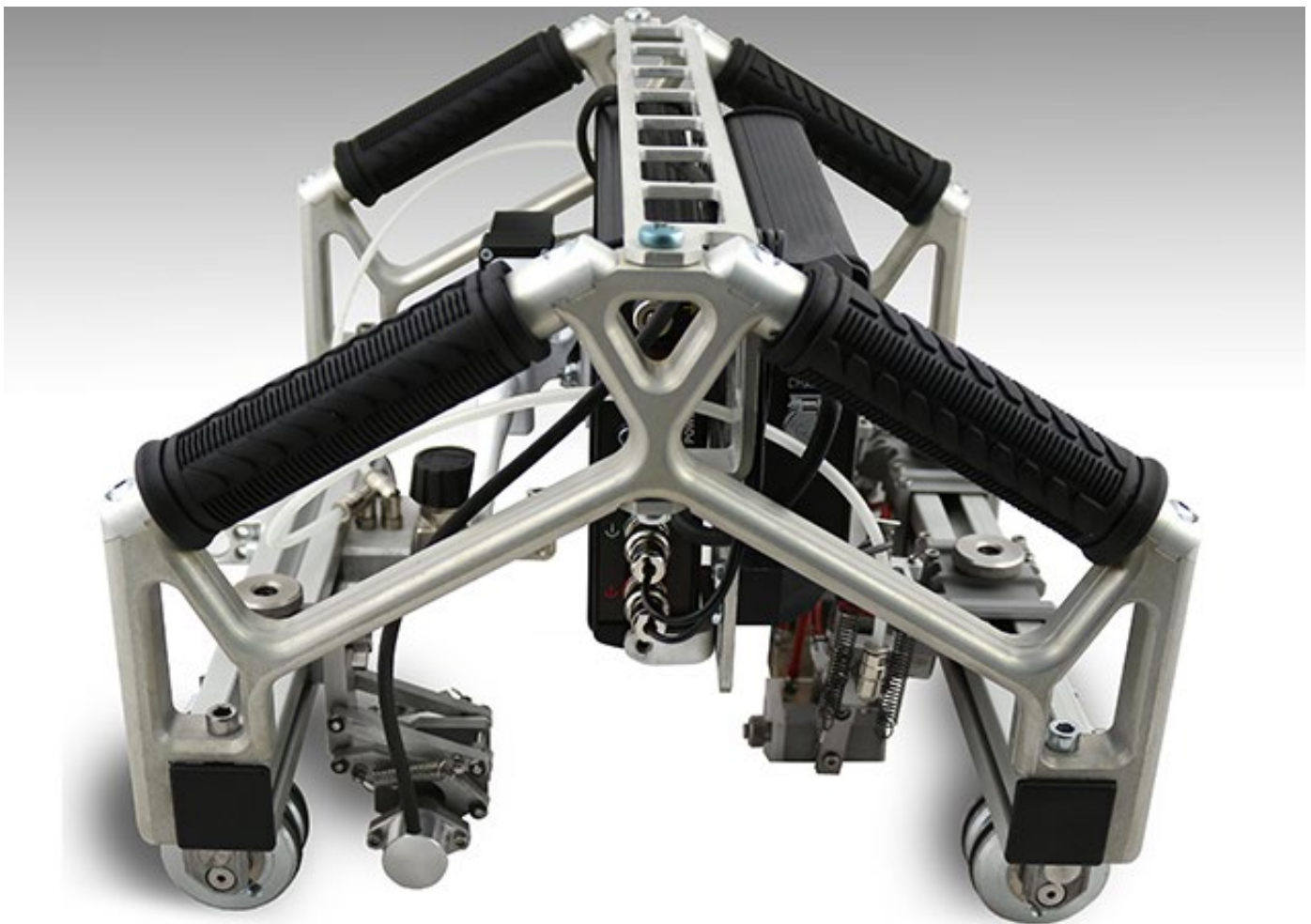



OKOndt GROUP

www.oko-ndt.com

E-mail sales: global-sales@oko-ndt.com